

MAKING ELECTRICAL CONNECTIONS
SAFER AND MORE CONVENIENT.

SHENZHEN WEICHAT TECHNOLOGY CO.,LTD.

Add: Building E, Xiashijia Second Industrial Zone
Ma Tian Street, Guangming New District, Shenzhen City, China
Sales Call: +86 755-23344535 Fax: +86 755-23348107
Email: info@weichatsz.com Website: www.e-weichat.com



COMPANY
WEBSITE

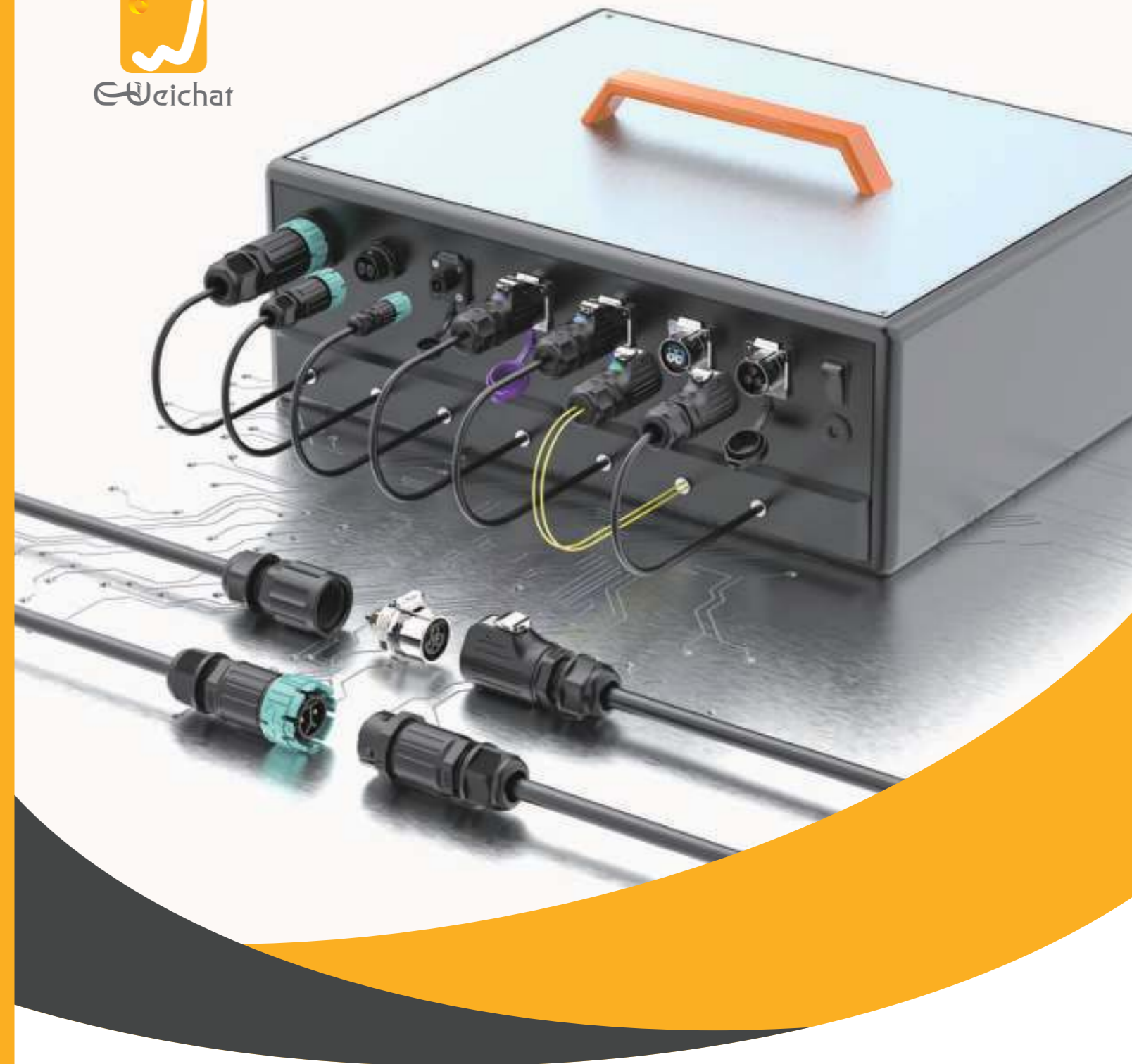

PRODUCT CATALOGUE

Shenzhen Weichat
Technology Co.,Ltd.

COMPANY PROFILE

Year Established: 2016

Business Type: IP68 Waterproof Connectors, IP68 Waterproof Junction Boxes,
Industrial & Device Connectors, New Energy Storage Connectors, PV Connectors...

Operations: Shenzhen, China. 6,300+ Sqm Manufacturing Base, 30+ Technical
Team, 160+ Manpower

Factory Qualifications: ISO9001, ISO14001, ISO13485

Product Certificates: UL/cUL, TUV, CE, UKCA, SAA, RoHS, CQC

Mission: Making electrical connections safer and more convenient

Business Philosophy: Quality First, Customer First, Integrity, Initiative, Innovation,
Keep Improving.



CERTIFICATES & QUALIFICATIONS

Weichat has been qualified with ISO9001, ISO14001 and ISO13485, and its products have obtained dozens of patents and certifications at home and abroad, like UL, cUL, TUV, UKCA, CE, SAA, CQC and RoHS...



HONORS

ENGINEER R&D TEAM

Weichat has a R&D team with nearly 10 years experience, which can help us to achieve 3 days for prototyping and 20 days for molding. OEM and ODM are acceptable. We can support our clients to turn their concepts into real products, and provide one stop solutions.

R&D team **30+**

Testing equipment **50+**

Automatic production **50+**

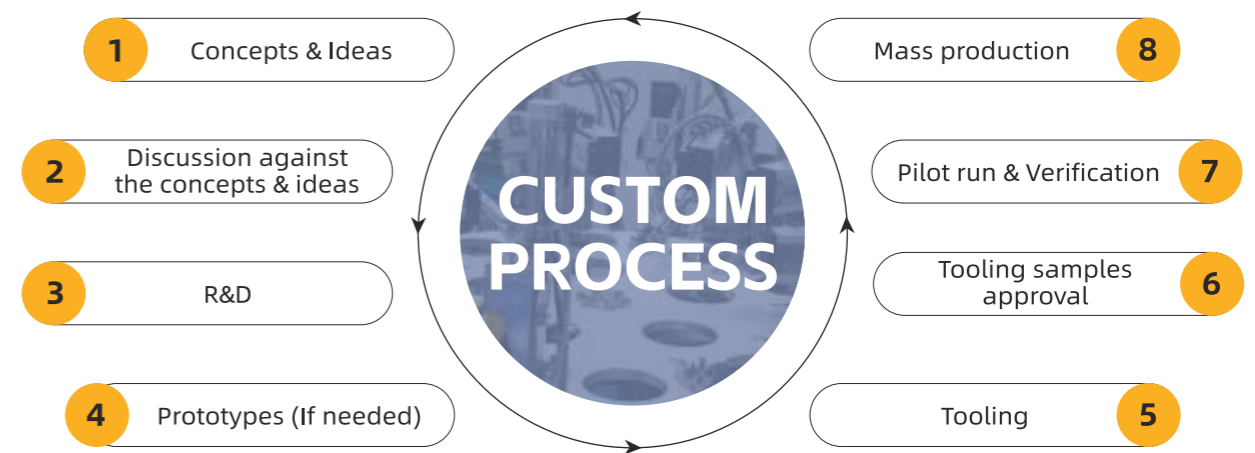

E-Weichat product

Weichat provides you with various types of IP68 waterproof industrial connectors, lighting connectors, junction boxes, energy storage connectors...



Industrial connector



Lighting connector



Electric enclosures



Energy storage connector

Manufacturing

Manufacturing Base: 6300+ Sqm / 68,000+ Sqf
Production Equipment: 100+

Man Power: 160+
Annual Production Capacity: 10,000,000+



EW-LP series

EW-LP series connectors adopt high precision and high quality one-key pluggable design, which integrates self-locking, waterproof, dustproof, and anti-UV features. The dimensions range from LP12 to LP28, including power supply, signal, and data applications. The LP series connectors are widely used in many kinds of challenging environments, such as communication, new energy, medical, robot, automation, LED display and many other industries.



EW-LP12

Power Supply: 2/3/4/5Pin				Signal: 6/7/8Pin			
Number of poles	2Pin	3Pin	4Pin	5Pin	6Pin	7Pin	8Pin
Soldering contact part	φ1*2	φ1*3	φ1*4	φ1*5	φ1*6	φ0.8*7	φ0.8*8
Screw contact part	φ1*2	φ1*3	×	×	×	×	×
Wire section	0.5mm ² /20AWG				0.34mm ² /22AWG		
Rated voltage	125V				100V		
Rated current	5A				3A		
Withstand voltage	1500V AC				1000V AC		
Contact resistance	≤ 5mΩ						
Temperature rise	5A 45K ↓				3A 45K ↓		
Insulation resistance	≥500MΩ						
Ambient temperature	-40°C~+85 °C						
Burn-in test	85°C 168H						
Mating cycle	≥1900						
IP Code	IP67 (IP68 Optional: 1M/2H)						
Outer cable diameter	φ5 ~ 7mm						

EW-LP16

Power Supply: 2/3/4Pin				Signal: 5/7/8/9Pin			
Number of poles	2Pin	3Pin	4Pin	5Pin	7Pin	8Pin	9Pin
Soldering contact part	φ1.5*2	φ1.5*3	φ1.5*4	φ1*5	φ1*7	φ1*8	φ1.0*9
Screw contact part	φ1.5*2	φ1.5*3	φ1.5*4	φ1*5	×	×	×
Wire section	1.5mm ² /16AWG				0.5mm ² /20AWG		
Rated voltage	400V				250V		
Rated current	10A				5A		
Withstand voltage	2000V AC				1500V AC		
Contact resistance	<3mΩ				<5mΩ		
Temperature rise	10A 45K ↓				5A 45K ↓		
Insulation resistance	≥1000MΩ						
Ambient temperature	-40°C~+85 °C						
Burn-in test	85°C 168H						
Mating cycle	≥1900						
IP Code	IP67 (IP68 Optional: 1M/2H)						
Outer cable diameter	Power supply class: φ7~9mm Signal class: φ4~6.5mm						

EW-LP20

Power Supply: 2/3/4Pin				Signal: 5/6/7/9/12Pin				
Number of poles	2Pin	3Pin	4Pin	5Pin	6Pin	7Pin	9Pin	12Pin
Soldering contact part	φ2.7*2	φ2.7*3	φ2.7*4	φ1.8*5	×	φ1.8*7	φ1*9	φ1*12
Screw contact part	φ2.7*2	φ2.7*3	φ2.7*4	φ1.8*5	φ1.8*6	φ1.8*7	×	×
Wire section	2.5~4mm ² 14~12AWG			1~1.5mm ² 18~16AWG		0.34~0.75mm ² 22~20AWG		
Rated voltage	500V AC				250V AC			
Rated current	20A				10A		5A	
Withstand voltage	2500V AC				2000V AC		1500V AC	
Contact resistance	<1mΩ				<3mΩ		<5mΩ	
Temperature rise	20A 30K ↓ 25A 40K ↓ 30A 50K ↓		10A 30K ↓ 15A 40K ↓ 20A 50K ↓		5A 30K ↓ 7A 40K ↓ 10A 50K ↓			
Insulation resistance	≥1000MΩ							
Ambient temperature	-40°C~+85 °C							
Burn-in test	85°C 168H							
Mating cycle	≥1900							
IP Code	IP67 (IP68 Optional: 1M/2H)							
Outer cable diameter	φ9~12mm φ5~6.5mm							

Dimension drawing (REF)

Category	S-terminal		L-terminal		Flange			Panel				
	A	B	A	B	A			A				
				Solder	Screw	Crimping	B	Solder	Screw	Crimping	B	
EW-LP12	23.2	47	19.3	48.3	22.2	27.4	×	20.8	24.2	27.4	×	19.3
EW-LP16	32	60	25.5	60	28.5	32	×	31.5	28.5	32	×	25.5
EW-LP20	38	70	31.8	72	31.2	×	×	32.7	31.2	×	×	31.8
EW-LP24	41.2	73.4	35	72.3	37.4	38.9	×	36.8	37.4	38.9	×	35
EW-LP28	53	93	43	92.8	×	53.5	48.3	41.5	×	53.5	48.3	43

Panel/flange arrangement dimensions

Category	Rear panel mount		Flange mount			
	φA	B	φC	φD	A	B
EW-LP12	φ12 ^{+0.2/-0.0}	11.5 ^{+0.2/-0.0}	φ2.3 ^{+0.2/-0.0}	φ12 ^{+0.2/-0.0}	13±0.1	13±0.1
EW-LP16	φ18.5 ^{+0.2/-0.0}	16.5 ^{+0.2/-0.0}	φ3.2 ^{+0.2/-0.0}	φ16.5 ^{+0.2/-0.0}	20±0.1	20±0.1
EW-LP20	φ22.5 ^{+0.2/-0.0}	20 ^{+0.2/-0.0}	φ3.2 ^{+0.2/-0.0}	φ21 ^{+0.2/-0.0}	22±0.15	22±0.15
EW-LP24	φ25.2 ^{+0.2/-0.0}	23.7 ^{+0.2/-0.0}	φ3.2 ^{+0.2/-0.0}	φ24 ^{+0.2/-0.0}	26±0.1	26±0.1
EW-LP28	φ29.5 ^{+0.2/-0.0}	28 ^{+0.2/-0.0}	φ3.2 ^{+0.2/-0.0}	φ28 ^{+0.2/-0.0}	28±0.1	28±0.1



EW-LP24

Power Supply: 2/3/4/5Pin Signal: 10/12/19/24Pin

Number of poles	2Pin	3Pin	4Pin	5Pin	10Pin	12Pin	19Pin	24Pin
Soldering contact part	φ3*2	φ3*3	φ3*4	×	φ1.5*10	φ1.5*12	φ1*19	φ1*24
Screw contact part	φ3*2	φ3*3	φ3*4	φ2*5	×	×	×	×
Wire section	6mm ² /10AWG 4mm ² /12AWG		4mm ² 12AWG	2.5mm ² 14AWG	1.5mm ² 16AWG	0.5mm ² 20AWG		
Rated voltage	300V/500V AC		500V AC	500V AC	400V AC		250V AC	
Rated current	35A/25A		25A	20A	10A		5A	
Withstand voltage	2000V AC		2000V AC	2000V AC	1500V AC		1000V AC	
Contact resistance	<1mΩ		<1mΩ	<1mΩ	<3mΩ		<5mΩ	
Temperature rise	35A 45K ↓ 25A 45K ↓		25A 45K ↓	20A 45K ↓	10A 45K ↓		5A 45K ↓	
Insulation resistance	≥1000MΩ							
Ambient temperature	-40°C~+85 °C							
Burn-in test	85°C 168H							
Mating cycle	≥1900							
IP Code	IP67 (IP68 Optional: 1M/2H)							
Outer cable diameter	φ9.5~14mm							

product name	EW-LP24-USB	EW-LP24-HDMI	EW-LP24-RJ45	EW-LP24-FIBER
Rated voltage	5V	5V	125V	/
Rated current	900mA	0.5A	1.5A	/
Return loss	/	/	/	≥50dB
Insertion loss	/	/	/	≤0.35dB



EW-LP28

Power Supply: 2/3Pin Signal: 3/5Pin (Line pressing style)

Number of poles	2Pin	3Pin	3Pin		5Pin	
Soldering contact part	×	×	φ3.5*3	φ1.5	φ3.5*5	φ1.5
Screw contact part	φ4*2	φ4*3	×		×	
Wire section	10mm ²		2.5mm ² 6mm ²	0.5mm ²	2.5mm ² 6mm ²	0.5mm ²
Rated voltage	500V		480V	/	480V	/
Rated current	50A		16A, 32A	3A	16A, 32A	3A
Withstand voltage	2500V AC		2500V AC	/	2500V AC	/
Contact resistance	≤1mΩ					
Temperature rise	50A 45K ↓		16A 45K ↓ / 32A 45K ↓			
Insulation resistance	≥1000MΩ					
Ambient temperature	-40°C~+85 °C					
Burn-in test	85°C 168H					
Mating cycle	>600					
IP Code	IP67 (IP68 Optional: 1M/2H)					
Outer cable diameter	φ16.5~18.5mm		φ10.5~16.5mm			



Screw free wiring series

Pull the wrenches up, insert the conductors, and then push the wrenches down back. 3 steps only and tools free to finish wiring. Weichat screw free fast wiring series connectors contain straight through, panel mount, T style and X style to satisfy various installation demands.

Installation diagram

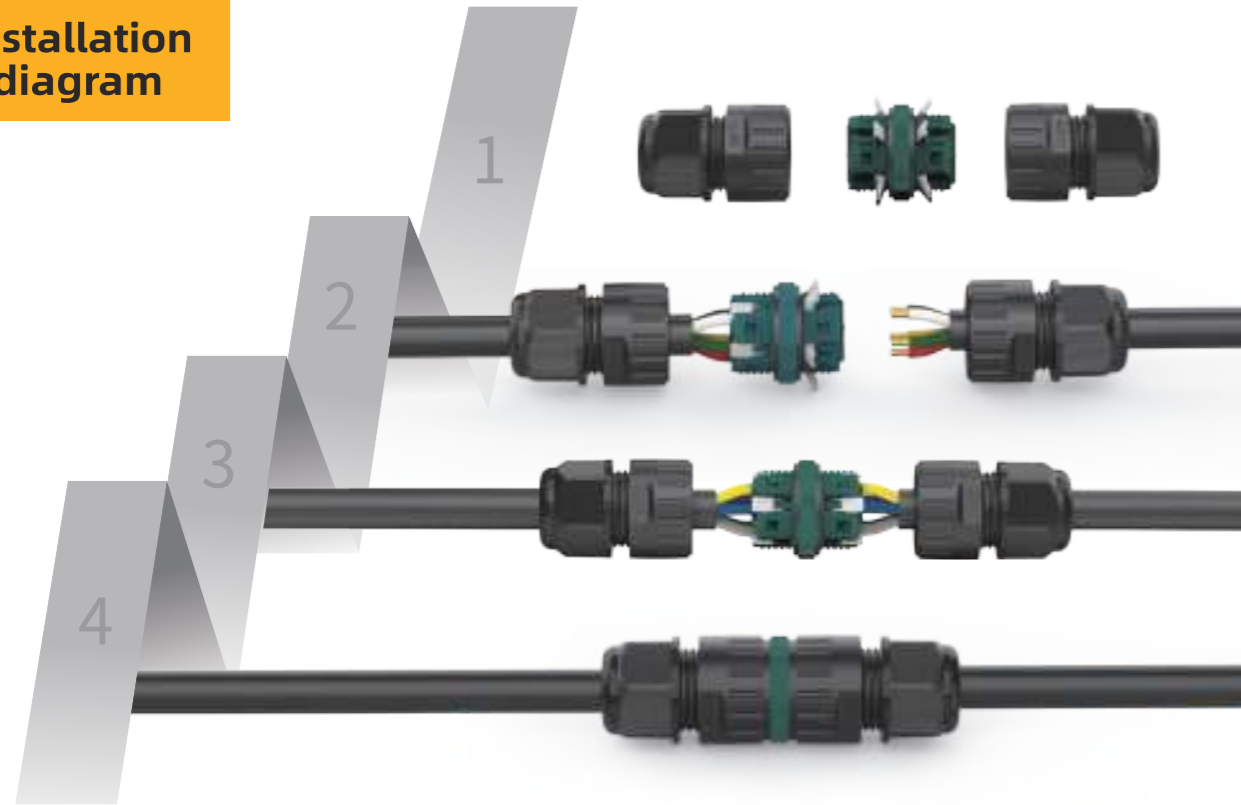

EW-P20

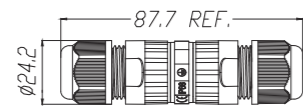

Number of poles: 2/3Pin
 Rated voltage: 450V
 Rated current: 16A
 Wire section: 0.5-2.5mm²
 Outer cable diameter: 3-5mm, 3.5-7mm, 5-9mm, 9-12mm
 Ambient temperature: -40°C~+105°C
 IP Code: IP68

EW-P25



Number of poles: 4/5Pin
 Rated voltage: 450V
 Rated current: 16A
 Wire section: 0.5-2.5mm²
 Outer cable diameter: 5-9mm, 9-12mm, 10-14mm
 Ambient temperature: -40°C~+105°C
 IP Code: IP68

EW-M25B

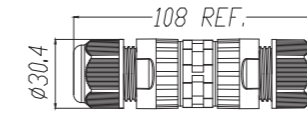

Number of poles: 2/3Pin
 Rated voltage: 250V
 Rated current: 24A
 Wire section: 0.5-2.5mm²
 Outer cable diameter: 5-9mm, 9-12mm, 10-14mm
 Ambient temperature: -40°C~+105°C
 IP Code: IP68

EW-P20T-B02

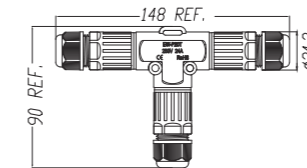

Number of poles: 2Pin
 Rated voltage: 250V
 Rated current: 24A
 Wire section: 0.5-2.5mm²
 Outer cable diameter: 5-9mm, 9-12mm
 Ambient temperature: -40°C~+105°C
 IP Code: IP68

EW-P20X

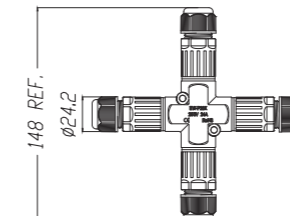

Number of poles: 2Pin
 Rated voltage: 250V
 Rated current: 24A
 Wire section: 0.5-2.5mm²
 Outer cable diameter: 5-9mm, 9-12mm
 Ambient temperature: -40°C~+105°C
 IP Code: IP68

EW-P20T

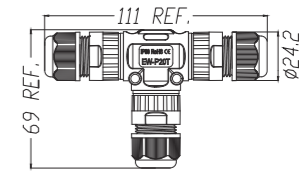

Number of poles: 2/3Pin
 Rated voltage: 450V
 Rated current: 16A
 Wire section: 0.5-2.5mm²
 Outer cable diameter: 5-9mm, 9-12mm
 Ambient temperature: -40°C~+105°C
 IP Code: IP68

EW-P25T

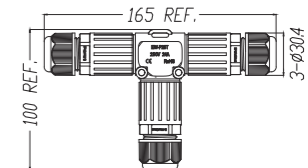

Number of poles: 3Pin
 Rated voltage: 250V
 Rated current: 24A
 Wire section: 0.5-2.5mm²
 Outer cable diameter: 5-9mm, 9-12mm, 10-14mm
 Ambient temperature: -40°C~+105°C
 IP Code: IP68

EW-P25X

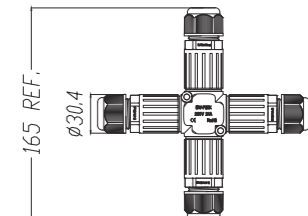

Number of poles: 3Pin
 Rated voltage: 250V
 Rated current: 24A
 Wire section: 0.5-2.5mm²
 Outer cable diameter: 5-9mm, 9-12mm, 10-14mm
 Ambient temperature: -40°C~+105°C
 IP Code: IP68

Screw wiring series

The conventional screw wiring series connectors with round pole sockets can properly protect the installed equipment even in water environment. This series connectors include straight type, T type, Y type and X type.



EW-M16

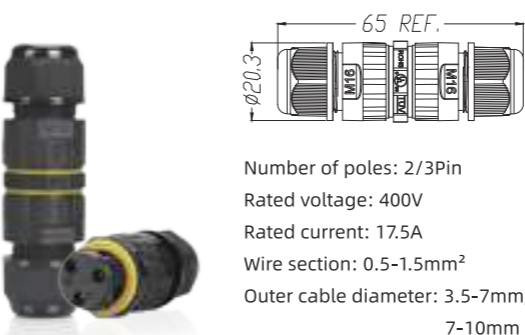

Number of poles: 2/3Pin
 Rated voltage: 400V
 Rated current: 17.5A
 Wire section: 0.5-1.5mm²
 Outer cable diameter: 3.5-7mm, 5-8mm, 7-10mm
 Ambient temperature: -40°C~+105°C
 IP Code: IP68

EW-M20

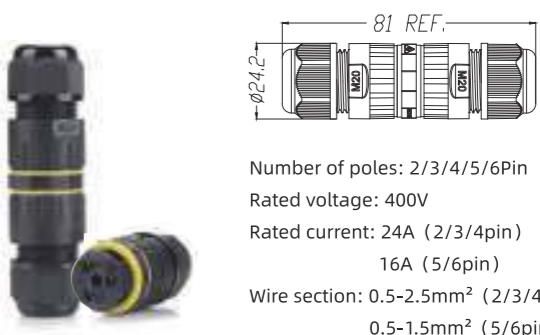

Number of poles: 2/3/4/5/6Pin
 Rated voltage: 400V
 Rated current: 24A (2/3/4pin)
 16A (5/6pin)
 Wire section: 0.5-2.5mm² (2/3/4pin)
 0.5-1.5mm² (5/6pin)
 Outer cable diameter: 3-5mm, 3.5-7mm, 5-9mm, 9-12mm
 Ambient temperature: -40°C~+105°C
 IP Code: IP68

EW-M25

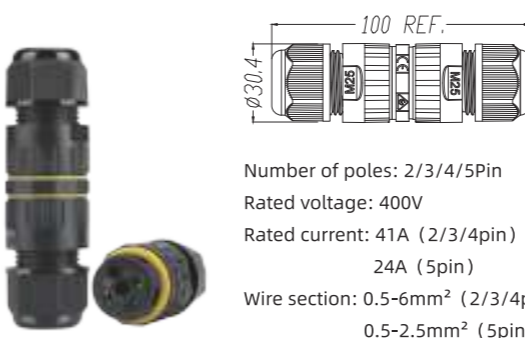

Number of poles: 2/3/4/5Pin
 Rated voltage: 400V
 Rated current: 41A (2/3/4pin)
 24A (5pin)
 Wire section: 0.5-6mm² (2/3/4pin)
 0.5-2.5mm² (5pin)
 Outer cable diameter: 5-9mm, 9-12mm, 10-14mm
 Ambient temperature: -40°C~+105°C
 IP Code: IP68

EW-M25I

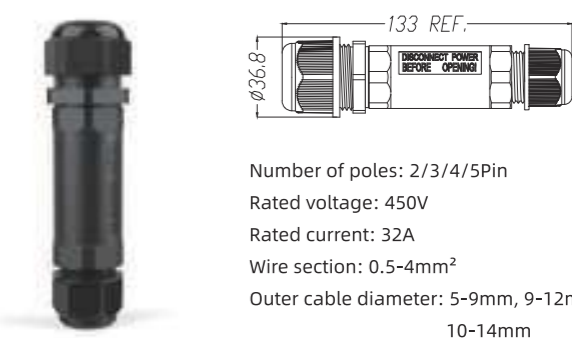

Number of poles: 2/3/4/5Pin
 Rated voltage: 450V
 Rated current: 32A
 Wire section: 0.5-4mm²
 Outer cable diameter: 5-9mm, 9-12mm, 10-14mm
 Ambient temperature: -40°C~+105°C
 IP Code: IP68

EW-M25-3T/4T/5T

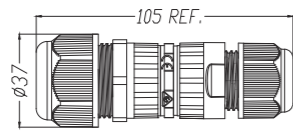

Number of poles: 2/3/4Pin
 Rated voltage: 450V
 Rated current: 41A
 Wire section: 0.5-6mm²
 Outer cable diameter: 5-9mm, 9-12mm, 10-14mm, 14-18mm
 Ambient temperature: -40°C~+105°C
 IP Code: IP68



EW-M20T

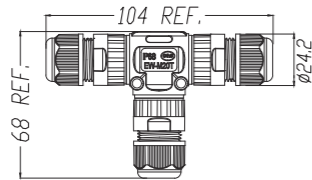

Number of poles: 2/3/4Pin
 Rated voltage: 400V
 Rated current: 24A
 Wire section: 0.5-2.5mm²
 Outer cable diameter: 5-9mm, 9-12mm
 Ambient temperature: -40°C~+105°C
 IP Code: IP68

EW-M25T

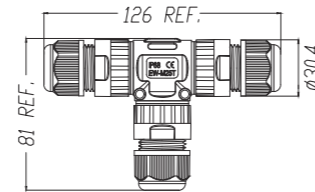

Number of poles: 2/3Pin
 Rated voltage: 450V
 Rated current: 41A
 Wire section: 1.5-6mm²
 Outer cable diameter: 5-9mm, 9-12mm, 10-14mm
 Ambient temperature: -40°C~+105°C
 IP Code: IP68

EW-M25TC

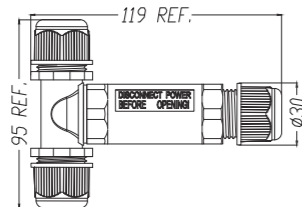

Number of poles: 2/3/4/5Pin
 Rated voltage: 450V
 Rated current: 32A
 Wire section: 0.5-4mm²
 Outer cable diameter: 5-9mm, 9-12mm, 10-14mm
 Ambient temperature: -40°C~+105°C
 IP Code: IP68

EW-M25Y

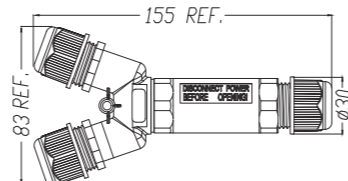

Number of poles: 2/3/4/5Pin
 Rated voltage: 450V
 Rated current: 32A
 Wire section: 0.5-4mm²
 Outer cable diameter: 5-9mm, 9-12mm, 10-14mm
 Ambient temperature: -40°C~+105°C
 IP Code: IP68

EW-M20X

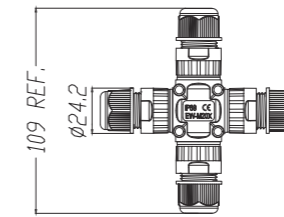

Number of poles: 2/3Pin
 Rated voltage: 450V
 Rated current: 24A
 Wire section: 0.5-2.5mm²
 Outer cable diameter: 3-5mm, 5-9mm, 9-12mm
 Ambient temperature: -40°C~+105°C
 IP Code: IP68

EW-M25X

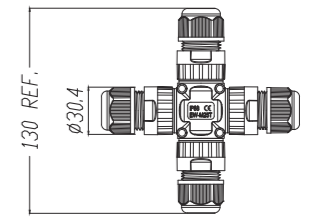

Number of poles: 2/3Pin
 Rated voltage: 450V
 Rated current: 41A
 Wire section: 1.5-6mm²
 Outer cable diameter: 5-9mm, 9-12mm, 10-14mm
 Ambient temperature: -40°C~+105°C
 IP Code: IP68

EW-L02/L03

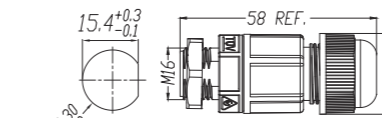

Number of poles: 2/3Pin
 Rated voltage: 400V
 Rated current: 24A
 Wire section: 0.5-2.5mm²
 Outer cable diameter: 3.5-7mm, 7-10mm
 Ambient temperature: -40°C~+105°C
 IP Code: IP68

EW-B02

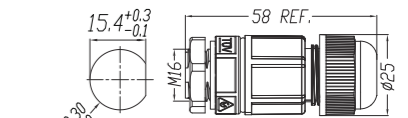

Number of poles: 2Pin
 Rated voltage: 450V
 Rated current: 16A
 Wire section: 0.2-0.5mm²
 Outer cable diameter: 3.5-7mm, 7-10mm
 Ambient temperature: -40°C~+105°C
 IP Code: IP68





Self locking style Male & Female series

Align the male and female parts to plug in, the connector will be self locked automatically, and twist the center self locking shell left or right a little bit to separate the male and female parts.

With its compact design, Weichat patented self locking style male and female series connectors can be used in many harsh environments. This series connectors have 3 types of wiring approaches, screw wiring, screw free fast wiring and solder wiring.

outline dimension (REF)										
Category	M-terminal		F-terminal		Front panel		Rear panel		Flange	
Diagram										
	A	B	A	B	A	B	A	B	A	B
EW-M15	19	52	18.4	52	29.9	20.5	/	/	30.7	35.2
EW-M19	24.2	58	22.7	57	30.9	23.2	31	22	31	35.2
EW-M23	27.8	66	26.9	66	30.9	29.4	30.9	26.9	31.3	37.2
EW-M28	32	80	32.9	80	35.5	38.2	35.5	32.8	35.4	41.2
EW-P23	27.8	72.4	26.9	69.7	/	/	33.7	36	32.6	37.2
EW-P25	32	86.3	30.4	83.4	/	/	32.6	36	34.2	41.2

Panel/flange arrangement dimensions									
Category	Panel mount				Flange mount				
Diagram									
	Front		Rear		phi 3.2	phi C	phi D	A	B
	phi A	B	phi A	B					
EW-M15	phi 15.7	14.5	/	/					
EW-M19	phi 20.4	19	phi 16.4	15.5					
EW-M23	phi 25.1	23.3	phi 20.5	19.6					
EW-M28	phi 26.8	25.4	phi 25.6	24.5					
EW-P23	/	/	phi 20.5	/					
EW-P25	/	/	phi 25.2	/					

EW-M15



Number of poles: 2/3/4Pin
Rated voltage: 450V
Rated current: 10A
Wire section: 0.5-1.5mm²
Outer cable diameter: 2.5-4.5mm, 3.5-7mm
Mating cycle: 1500 Mating Cycles
Ambient temperature: -40°C~+105°C
IP Code: IP68

EW-M19



Number of poles: 2/3/4/5Pin
Rated voltage: 450V
Rated current: 20A (2/3pin)
16A (4/5pin)
Wire section: 0.5-2.5mm² (2/3pin)
0.5-1.5mm² (4/5pin)
Outer cable diameter: 3.5-7mm, 5-8mm,
7-10mm
Mating cycle: 1500 Mating Cycles
Ambient temperature: -40°C~+105°C
IP Code: IP68

EW-M23



Number of poles: 2/3/4/5Pin
Rated voltage: 450V
Rated current: 30A (2/3pin)/16A (4/5pin)
Wire section: 0.5-4mm² (2/3pin)
0.5-2.5mm² (4/5pin)
Outer cable diameter: 5-9mm, 9-12mm
Mating cycle: 1500 Mating Cycles
Ambient temperature: -40°C~+105°C
IP Code: IP68

EW-M28



Number of poles: 2/3/4/5/6Pin
Rated voltage: 450V
Rated current: 41A (2/3/4pin)
20A (5/6pin)
Wire section: 0.5-6mm² (2/3/4pin)
0.5-2.5mm² (5/6pin)
Outer cable diameter: 5-9mm, 9-12mm,
10-14mm
Mating cycle: 1500 Mating Cycles
Ambient temperature: -40°C~+105°C
IP Code: IP68

EW-P23



Number of poles: 2/3Pin
Rated voltage: 450V
Rated current: 16A
Wire section: 0.5-2.5mm²
Outer cable diameter: 5-9mm, 9-12mm
Mating cycle: 1500 Mating Cycles
Ambient temperature: -40°C~+105°C
IP Code: IP68

EW-P25



Number of poles: 4/5Pin
Rated voltage: 450V
Rated current: 16A
Wire section: 0.5-2.5mm²
Outer cable diameter: 5-9mm, 9-12mm,
10-14mm
Mating cycle: 1500 Mating Cycles
Ambient temperature: -40°C~+105°C
IP Code: IP68



Waterproof junction box series

2 way to 10 way IP68 waterproof junction boxes can be installed horizontally and vertically as external wiring devices.

Applications: Gas station, Mine, Workshop, Irrigation, Greenhouse, Monitoring, Submersible pump, and Energy distribution...



Optional wiring terminals



A



B



C



D

EW-M2068-2T

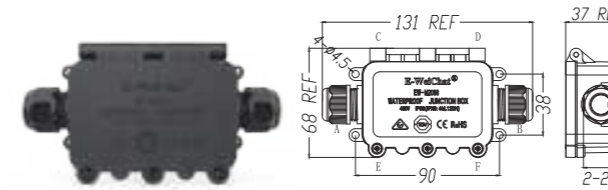

Rated voltage: 450V
 Rated current: 40A
 Wire section: 0.5-6mm²
 Outer cable diameter: M20*2: 5-9mm, 9-12mm
 Ambient temperature: -40°C~+105°C
 IP Code: IP68

EW-M2068-3T

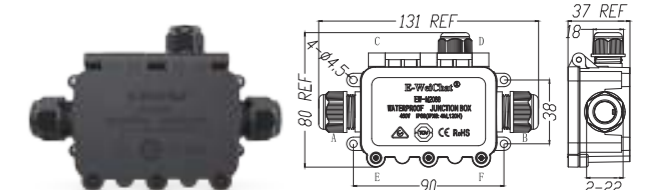

Rated voltage: 450V
 Rated current: 40A
 Wire section: 0.5-6mm²
 Outer cable diameter: M20*2: 5-9mm, 9-12mm
 M16*1: 3.5-7mm, 7-10mm
 Ambient temperature: -40°C~+105°C
 IP Code: IP68

EW-M2068-4TA

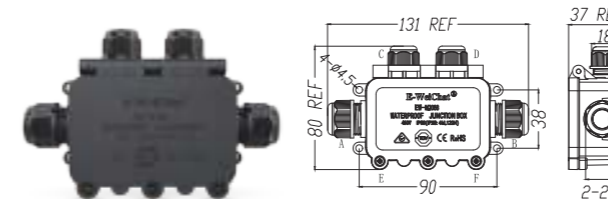

Rated voltage: 450V
 Rated current: 40A
 Wire section: 0.5-6mm²
 Outer cable diameter: M20*2: 5-9mm, 9-12mm
 M16*2: 3.5-7mm, 7-10mm
 Ambient temperature: -40°C~+105°C
 IP Code: IP68

EW-M2068-4TB

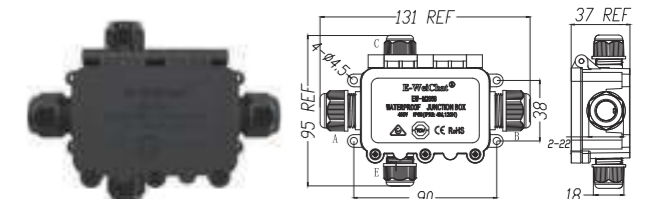

Rated voltage: 450V
 Rated current: 40A
 Wire section: 0.5-6mm²
 Outer cable diameter: M20*2: 5-9mm, 9-12mm
 M16*1: 3.5-7mm, 7-10mm
 Ambient temperature: -40°C~+105°C
 IP Code: IP68

EW-M2068-5T

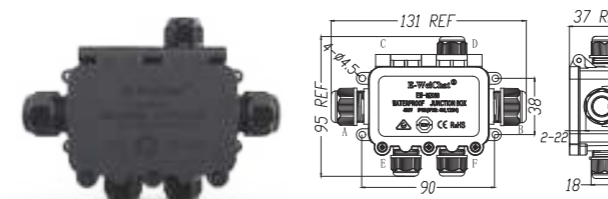

Rated voltage: 450V
 Rated current: 40A
 Wire section: 0.5-6mm²
 Outer cable diameter: M20*2: 5-9mm, 9-12mm
 M16*3: 3.5-7mm, 7-10mm
 Ambient temperature: -40°C~+105°C
 IP Code: IP68

EW-M2068-6T

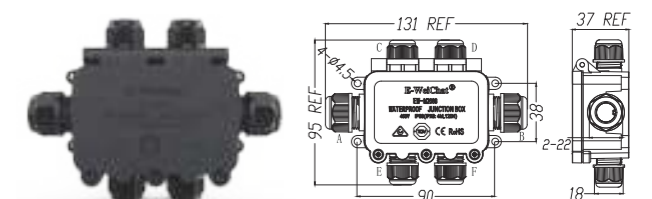

Rated voltage: 450V
 Rated current: 40A
 Wire section: 0.5-6mm²
 Outer cable diameter: M20*2: 5-9mm, 9-12mm
 M16*4: 3.5-7mm, 7-10mm
 Ambient temperature: -40°C~+105°C
 IP Code: IP68

EW-M2068(L)-H

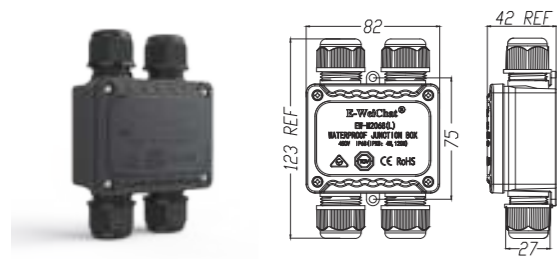

Rated voltage: 450V
 Rated current: 40A
 Wire section: 0.5-6mm²
 Outer cable diameter: M25*4: 5-9mm, 9-12mm, 10-14mm
 Ambient temperature: -40°C~+105°C
 IP Code: IP68

EW-M2068(L)-T

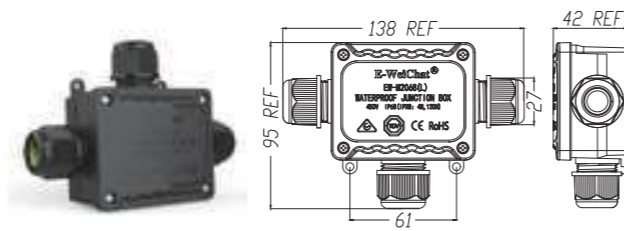

Rated voltage: 450V
 Rated current: 40A
 Wire section: 0.5-6mm²
 Outer cable diameter: M25*3: 5-9mm, 9-12mm, 10-14mm
 Ambient temperature: -40°C~+105°C
 IP Code: IP68

EW-M2068S-2T

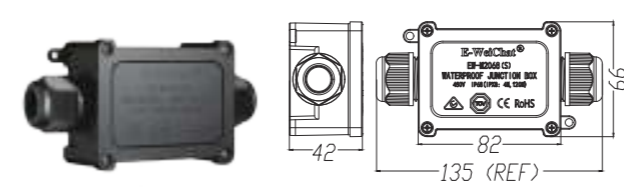

Rated voltage: 450V
 Rated current: 40A
 Wire section: 0.5-6mm²
 Outer cable diameter: M25*2: 5-9mm, 9-12mm, 10-14mm
 Ambient temperature: -40°C~+105°C
 IP Code: IP68

EW-M2068S-3T

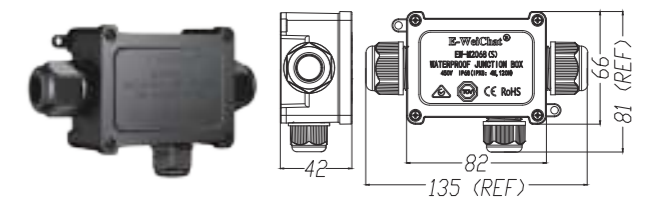

Rated voltage: 450V
 Rated current: 40A
 Wire section: 0.5-6mm²
 Outer cable diameter: M20*1: 5-9mm, 9-12mm
 M25*2: 5-9mm, 9-12mm, 10-14mm
 Ambient temperature: -40°C~+105°C
 IP Code: IP68

EW-M2068(L)-Y

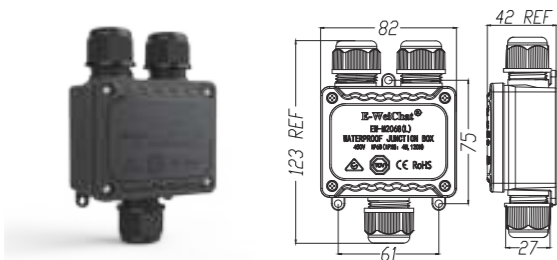

Rated voltage: 450V
 Rated current: 40A
 Wire section: 0.5-6mm²
 Outer cable diameter: M25*3: 5-9mm, 9-12mm, 10-14mm
 Ambient temperature: -40°C~+105°C
 IP Code: IP68

EW-M2068(XL)-4T

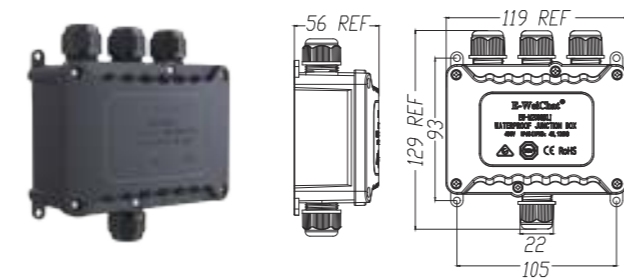

Rated voltage: 450V
 Rated current: 40A
 Wire section: 0.5-6mm²
 Outer cable diameter: M20*4: 5-9mm, 9-12mm
 Ambient temperature: -40°C~+105°C
 IP Code: IP68

EW-M2068S-4TA

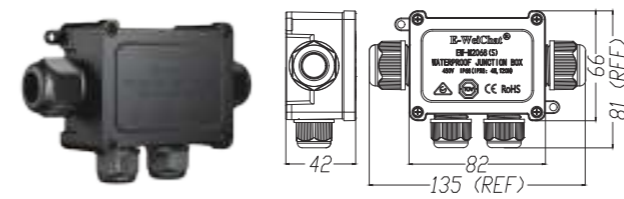

Rated voltage: 450V
 Rated current: 40A
 Wire section: 0.5-6mm²
 Outer cable diameter: M20*2: 5-9mm, 9-12mm
 M25*2: 5-9mm, 9-12mm, 10-14mm
 Ambient temperature: -40°C~+105°C
 IP Code: IP68

EW-M2068S-4TB

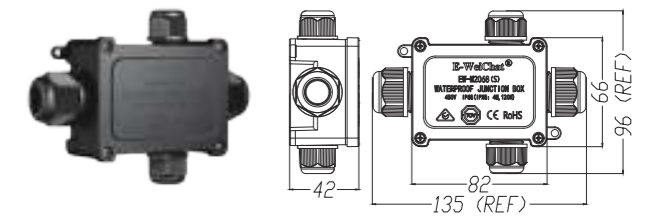

Rated voltage: 450V
 Rated current: 40A
 Wire section: 0.5-6mm²
 Outer cable diameter: M20*2: 5-9mm, 9-12mm
 M25*2: 5-9mm, 9-12mm, 10-14mm
 Ambient temperature: -40°C~+105°C
 IP Code: IP68

EW-M2068(XL)-10T

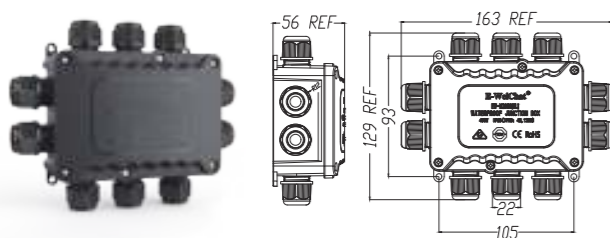

Rated voltage: 450V
 Rated current: 40A
 Wire section: 0.5-6mm²
 Outer cable diameter: M20*10: 5-9mm, 9-12mm
 Ambient temperature: -40°C~+105°C
 IP Code: IP68

EW-M2068(XL)

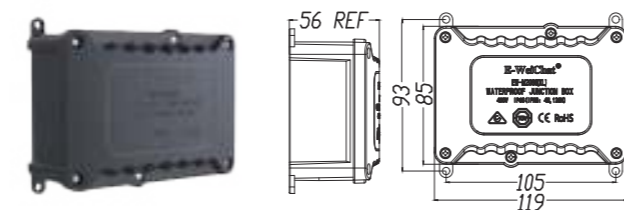

Acceptable for customization

EW-M2068S-5T

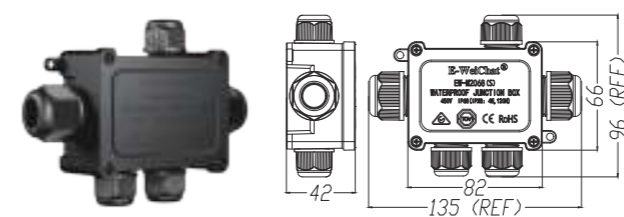

Rated voltage: 450V
 Rated current: 40A
 Square number of lines: 0.5-6mm²
 Outer cable diameter: M20*3: 5-9mm, 9-12mm
 M25*2: 5-9mm, 9-12mm, 10-14mm
 Ambient temperature: -40°C~+105°C
 IP Code: IP68

EW-M2068S-6T

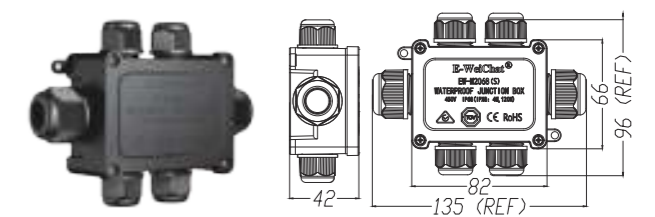

Rated voltage: 450V
 Rated current: 40A
 Square number of lines: 0.5-6mm²
 Outer cable diameter: M20*4: 5-9mm, 9-12mm
 M25*2: 5-9mm, 9-12mm, 10-14mm
 Ambient temperature: -40°C~+105°C
 IP Code: IP68



Energy storage series

Weichat's new energy storage connectors, ranging from 50A to 350A, can be widely used in PV, industrial energy storage, energy storage equipment, EV, electric motorcycles, process control, automation, heavy equipment, machinery and many other fields.

Applications



Energy-storage systems



New energy photovoltaic



Automation



Energy-storage systems



Smart parking system



Inverter



Heavy equipment

Accept to customize cable assembly



Technical data				
Plug type	E50	E70	E100	E120
Number of connections	1			
Plug in force	80N MAX			
Plug out force	<80N			
Rated voltage	1500V DC			
Rated current	50A	70A	100A	120A
Contact resistance	≤1mΩ			
Insulation resistance	500V, ≥500MΩ			
Colour	Orange/black/red			
Contact material	Silver/tin plated copper			
Insulation material	PA66+GF			
Water seal material	Silicone (black)	Silicone (blue)	Silicone (black)	Silicone (blue)
O-ring material	Silicone (red)			
Mating cycle	500 Mating cycles			
Outer cable diameter	5.2-6.3mm	6.2-7.3mm	6.5-8.5mm	8.5-10.5mm
Wire section	10AWG (6mm ²)	8AWG (10mm ²)	6AWG (16mm ²)	4AWG (25mm ²)
Cable stripping length	10-12mm		12-14mm	
Connection mode	Crimping			
IP Rating (opposite insertion)	IP67			
Operating temperature	-40°C~+125°C			
Ambient temperature (storage/transportation)	-40°C~+80°C			
Halogen free	Compliant			
Fire rating	UL94 V-0			

Socket size (REF)								
Category	Copper bar with unthreaded hole		Crimping type		Stud type		Copper bar with threaded hole	
Measure								
	A	B	A	B	A	B	A	B
50A/70A	16.3	48.6	16.3	43.6	16.3	41.6	16.3	48.6
100A/120A	20.9	56.9	20.9	55.9	20.9	51.2	20.9	56.9
150A/200A/250A	22.1	63.5	22.1	63.5	22.1	61.2	22.1	63.5
300A/350A	Positive: 29 Negative: 30.5	Positive: 81 Negative: 82.5	Positive: 29 Negative: 30.5	Positive: 81 Negative: 82.5	Positive: 29 Negative: 30.5	Positive: 75 Negative: 76.5	Positive: 29 Negative: 30.5	Positive: 81 Negative: 82.5

Plug size (REF)				
Category	Crimping type			
Measure				
	A	B	C	D
50A/70A	21	50.5	25	17
100A/120A	26.7	69.3	32.7	19.3
150A/200A/250A	32.8	86	40.6	Positive: 24.1/Negative: 24.3
300A/350A	40.5	113	54.3	31.9

Technical data				
E150	E200	E250	E300	E350
1				
100N MAX				
<80N				
1500V DC				
150A	200A	250A	300A	350A
≤1mΩ				
500V, ≥500MΩ				
Orange/black/red				
Silver/tin plated copper				
PA66+GF				
Silicone (black)	Silicone (black)	Silicone (black)	Silicone (gray)	Silicone (blue)
Silicone (red)				
100 Mating cycles				
13mm	14mm	15mm	17.5mm	20mm
2AWG (35mm ²)	1/0AWG (50mm ²)	2/0AWG (70mm ²)	3/0AWG (95mm ²)	4/0AWG (120mm ²)
17mm			19mm	
Crimping				
IP67				
-40°C~+125°C				
-40°C~+80°C				
Compliant				
UL94 V-0				

Panel mount dimensions								
Current	A	B	φC	D	Panel mount torque	Copper bar screw connection torque	Stud connection torque	Diagram
50A/70A	24±0.1	/	12.9±0.1	M4 Screw	0.4-0.7N.m	M4 bolts: 1.2-1.5N.m	M4 Nut: 1.2-1.5N.m	
100A/120A	18±0.1		14.5±0.1		M4 bolts: 0.4-0.7N.m	M5 bolts: 2N.m max	M6 Nut: 2N.m max	
150A/200A/250A	23±0.1		23.0 ^{+0.2} _{-0.0}		M8 bolts: 8N.m max	M8 bolts: 8N.m max	M8 Nut: 8N.m max	
300A/350A	24.5±0.1		22.5 ^{+0.2} _{-0.0}					

Copper plug specification				
Product description	3.6mm	5.8mm	9.6mm	12.4mm
Rated current	50A-70A	100A-120A	150A-250A	300A-350A
Working temperature	-40°C~+125 (1500V DC)			
IP Rating	IP67			
Fire-protection rating	UL94 V-0			
Shackle	Spring lock			
RoHS	Compliant			
Mating cycle	≥100			

Socket type	EW-50A/70A/100A/120A/150A/200A/250A/300A/350A
Wiring style	Copper bar, crimping, screw, copper bar/threaded
Tightening torque of mounting nut	M4/0.4-0.7N.m
Waterproof gasket material	Silicone (transparent)

PV4 photovoltaic series

Weichat's PV4 connectors conform to the criteria of ground photovoltaic system of GB/T33765, TUV/IEC62852. The high performance PP0 engineering plastic material protect the products in terms of electrical reliability, high temp shock resistance and anti-UV, as well, the copper alloy conductor components can ensure the product works properly even under high temperatures.



Technical data

Operating voltage	1000V DC/1500V DC	
Operating current	UL 14AWG: 15A	TUV 2.5mm ² : 25A
	UL 12AWG: 20A	TUV 4mm ² : 35A
	UL 10AWG: 30A	TUV 6mm ² : 45A
	UL 8AWG: 50A	TUV 10mm ² : 65A
Withstand voltage	8000V DC	
Withstand pulse voltage	16KV (1.2/50us)	
Contact resistance	0.5mΩ Max	
Insulation resistance	500MΩ Min	
IP Rating	IP68 (1M/2H)	
Fire rating	UL94 V-0	
Ambient temperature	-40°C~+85°C	
Mating cycles	>100	
Life span	25 years	
Certificates	TUV/IEC62852/RoHS/REACH	
Outer cable diameter	5-7.8mm	

Materials and technology

Component name	Material
Housing	PPO
conductor	Tin plated copper alloy
Locking nut	PPO
Cord grip	PA
Fixing clip	Stainless steel
Water seal	Silicon

EW-PV4F-120XX1 PV4 cable mount female plug



EW-PV4M-121XX1 PV4 cable mount male plug, Tool unlock



EW-PV4M-122XX1 PV4 cable mount male plug, Manual unlock



EW-PV4F-110XX1 PV4 panel mount female plug



EW-PV4M-111XX1 PV4 panel mount male plug, Tool unlock



EW-PV4M-112XX1 PV4 panel mount male plug, Manual unlock



EW-PV4-XXXXXX PV4 fuse

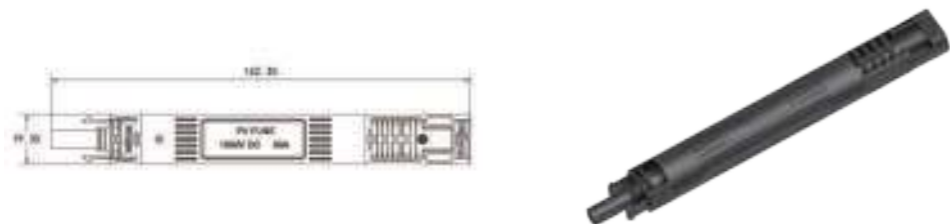

ODM Customization Cases

With its professional R&D team, powerful technical support and rich experiences, Weichat is willing to support all our clients to do your exclusive designs. We can make your idea or concepts to be final real products.

Case show

